

Roll Planishers

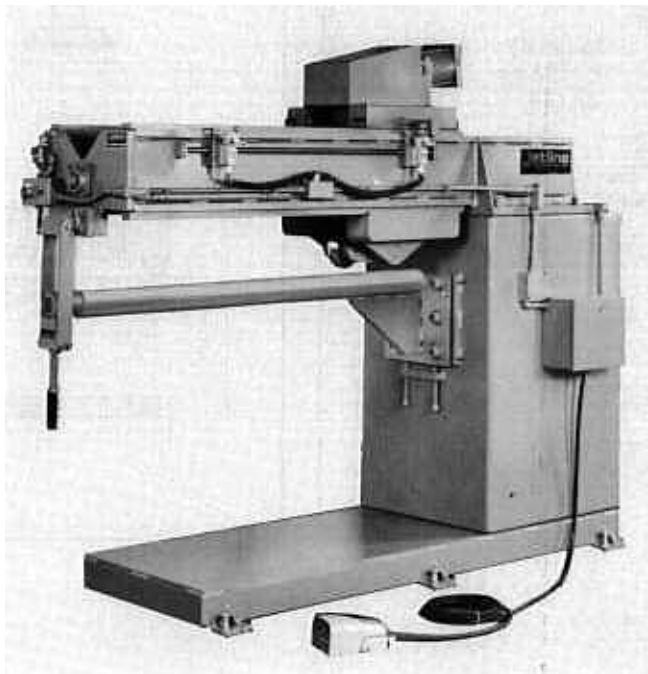

jetline[®]
engineering, inc.

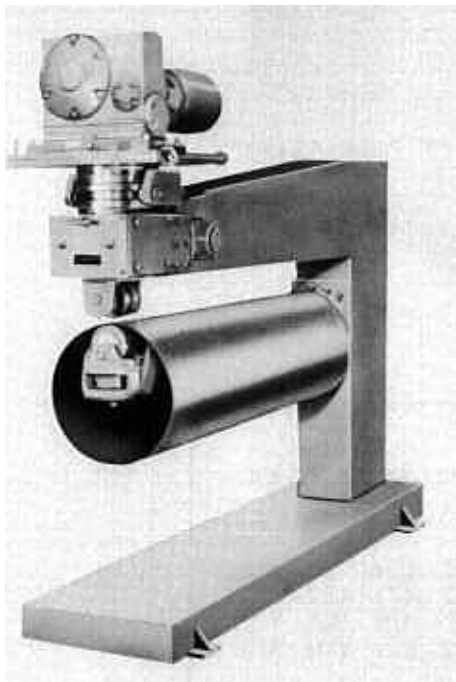
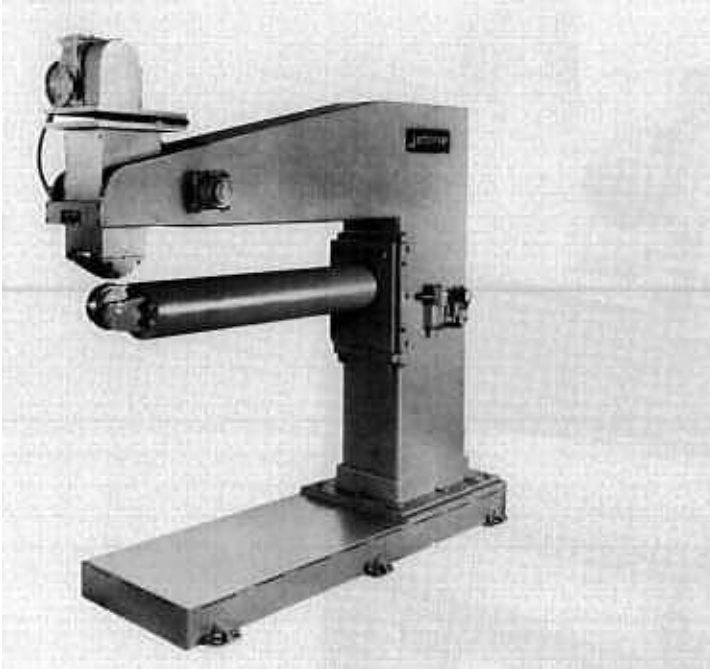
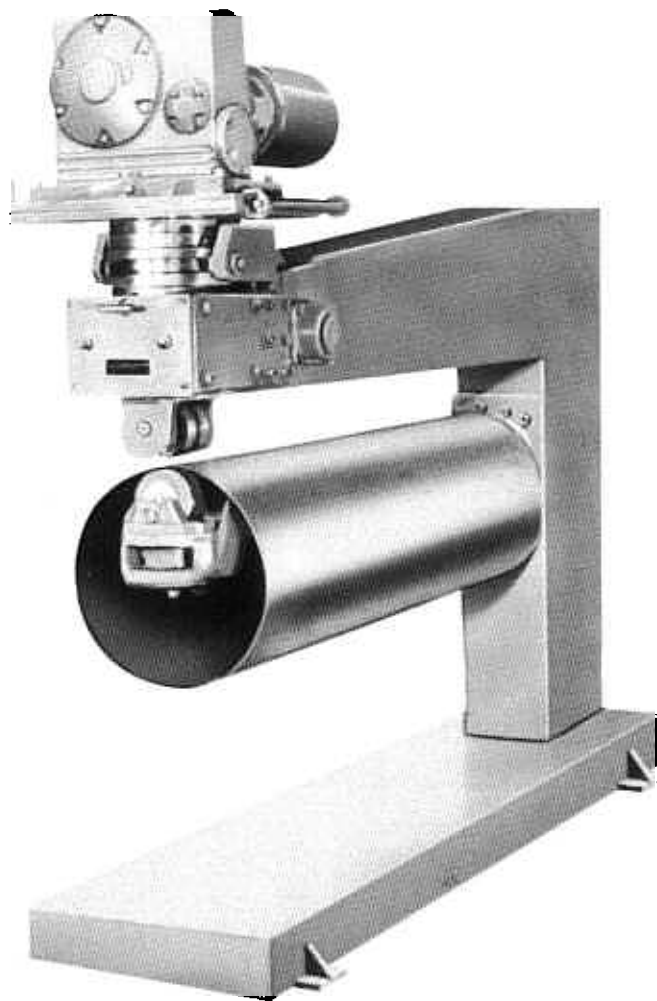

Universal Planishers

This model features upper and lower roll assemblies which pivot 90° to allow planishing of longitudinal as well as circumferential seams. The part moves during planishing on this model. Typical applications are rocket motor cases, milk tanks & jet engine parts.

Specifications

	RU3-XX	RU5-XX
Planishing Force	13,000	20,000
Thickness Capacity		
Steel or Aluminum	.005 - 3/16 (.02 - 4.7)	.005 - 1/4 (.02 - 6.4)
Stainless Steel	.005 - 1/8 (.02 - 3.2)	.005 - 3/16 (.02 - 4.7)

Common Dimensions

C (Maximum Diameter Piecepart)	36 (91.4)	36 (91.4)
D (Overall Height)	76 (193.8)	75 (191.3)
E (Overall Width)	31 (79)	31 (79)

Model Number	"A" Planishing Length		"B" Min. Dia. Piecepart		"F" Overall Length		Approx. Shipping Weight	
	In.	Cm	In.	Cm	In.	Cm	Lbs.	Kg
RU3-48	48	121.9	8	20.3	72	182.9	4,000	1810
RU3-60	60	152.4	9 1/4	23.5	84	198.1	5,000	2270
RU3-72	72	182.9	10 1/4	26.0	96	213.4	6,000	2720
RU3-96	96	243.8	12 1/4	31.1	108	243.8	8,000	3630
RU5-48	48	121.9	9 1/4	23.5	72	182.9	4,500	2040
RU5-60	60	152.4	10	25.4	84	198.1	5,500	2490
RU5-72	72	182.9	10 1/4	27.3	96	213.4	6,500	2950
RU5-96	96	243.8	13	33.0	108	243.8	8,500	3860

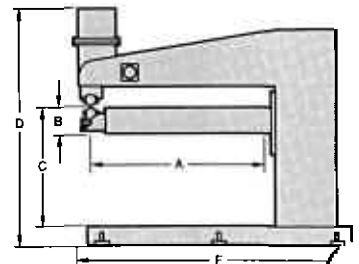

What is a Roll Planisher?

A Planisher is...

PURPOSE:

To remove weld build up. Results in a flush smooth weld.

FUNCTION:

Planishing is a quick inexpensive means of removing weld build up and improving surface finish. It is basically similar to a steel mill cold rolling operation only it is limited to the localized area of a weld.

ADVANTAGES:

1. Removes weld build up as much as 20 times faster than grinding and with no cost for consumable abrasive products.
2. Results in an excellent smooth cold rolled surface finish. This is especially important in stainless products requiring a polished surface.
3. Enhances weld metalurgical properties by cold working the "as cast" weld structure.
4. Causes the weld to spread out, often the same amount as the original shrinkage.

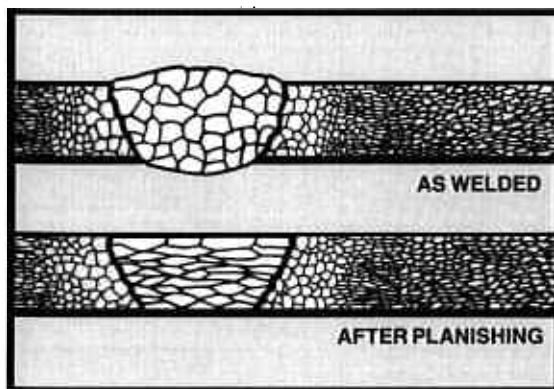
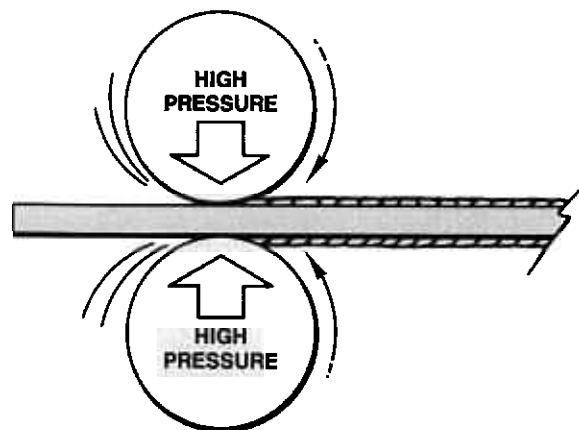

Contoured Rolls

One of the most significant features of Jetline's Roll Planisher is the interchangeability of the contoured rolls. These rolls remove the distortion caused by welding and return the piecepart to the configuration required.

Contoured rolls provide a quality finish without incorporating the costly grinding operation. Interchangeable flat rolls can be supplied for applications on flat panels, sheets and open end boxes.

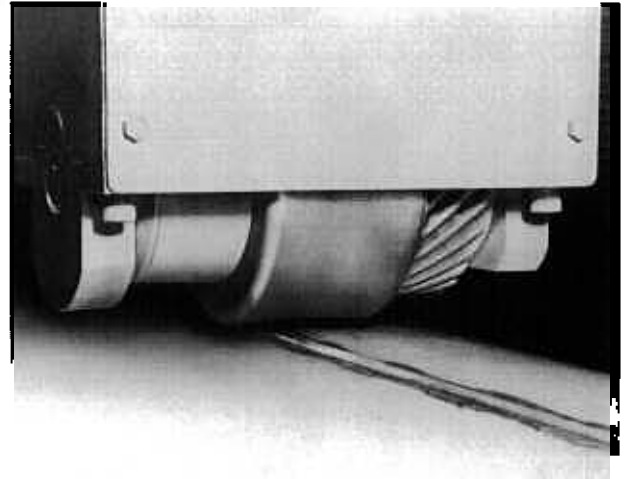

TYPICAL APPLICATIONS

- Stainless Food Handling Equipment
- Dairy Equipment
- Metal Bellows
- Chemical Process Tanks
- Stainless Pipe Fittings
- Missile Cases
- Aircraft Drop Tanks
- Automotive Sheet Splicing
- Tractor Wheels
- Cloth Dyeing Machinery
- Vacuum Thermos Bottles
- Water Heaters
- Aircraft Engine Parts
- Drug Handling Equipment

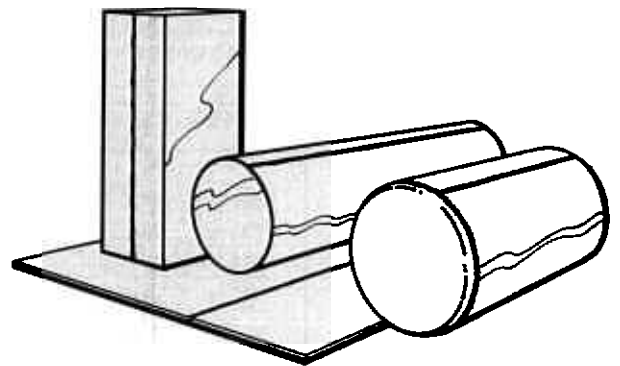

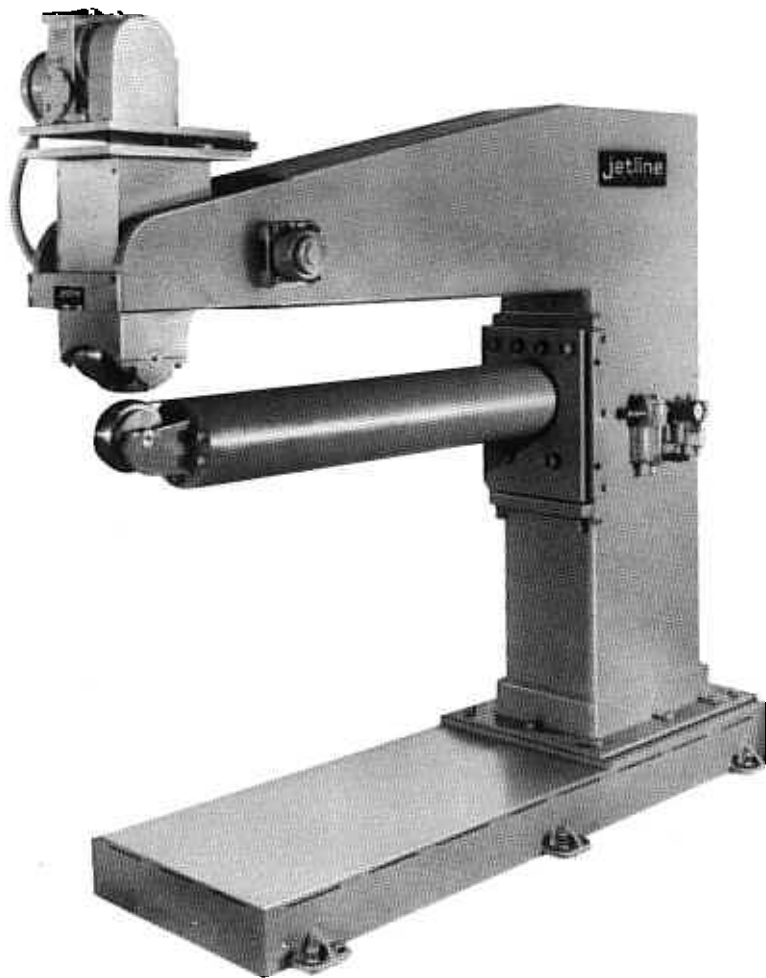

Longitudinal Planishers

These longitudinal models are specifically designed for planishing longitudinal seams. The part configuration can be anything that will fit over the mandrel arm. Part movement during planishing is powered by the upper roll.

Specifications

	RS3-XX	RS5-XX
Planishing Force	13,000	20,000
Thickness Capacity		
Steel or Aluminum	.005 - 3/16 (.02 - 4.7)	.005 - 1/4 (.02 - 6.4)
Stainless Steel	.005 - 1/8 (.02 - 3.2)	.005 - 3/16 (.02 - 4.7)

Common Dimensions

C (Maximum Diameter Piecepart)	36 (91.4)	36 (91.4)
D (Overall Height)	76 (193.8)	75 (191.3)
E (Overall Width)	31 (79)	31 (79)

Model Number	"A" Planishing Length		"B" Min. Dia. Piecepart		"F" Overall Length		Approx. Shipping Weight	
	In.	Cm	In.	Cm	In.	Cm	Lbs.	Kg
RS3-48	48	121.9	8	20.3	72	182.9	4,000	1810
RS3-60	60	152.4	9 1/4	23.5	84	198.1	5,000	2270
RS3-72	72	182.9	10 1/4	26.0	96	213.4	6,000	2720
RS3-96	96	243.8	12 1/4	31.1	108	243.8	8,000	3630
RS5-48	48	121.9	9 1/4	23.5	72	182.9	4,500	2040
RS5-60	60	152.4	10	25.4	84	198.1	5,500	2490
RS5-72	72	182.9	10 1/4	27.3	96	213.4	6,500	2950
RS5-96	96	243.8	13	33.0	108	243.8	8,500	3860

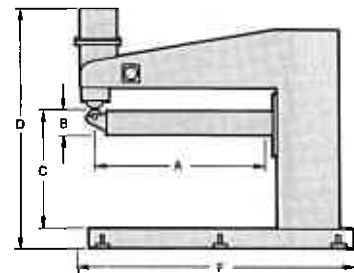



Gantry Planishers

...is best suited to a small diameter or special shaped mandrel arm. In this model the planishing wheel moves while the part remains stationary.

Specifications

	RG3-XX
Planishing Force	13,000
Thickness Capacity	
Steel or Aluminum	.005 - 3/16 (.02 - 4.7)
Stainless Steel	.005 - 1/8 (.02 - 3.2)

Common Dimensions

C (Maximum Diameter Piecepart)	36" (91.4)
D (Overall Height)	76" (193.8)
E (Overall Width)	31" (79)

Model Number	"A" Planishing Length In. Cm	"B" Min. Dia. Piecepart In. Cm	"F" Overall Length In. Cm	Approx. Shipping Weight Lbs. Kg
RG3-12	12 30.5	4 1/4 10.8	72 182.9	4,000 1810
RG3-18	18 45.7	4 3/4 12.1	78 198.1	4,300 1950
RG3-24	24 60.9	5 1/4 13.3	84 213.4	4,600 2090
RG3-36	36 91.4	6 1/4 15.9	96 243.8	4,900 2220
RG3-48	48 121.9	7 17.8	108 274.3	5,200 2360
RG3-60	60 152.4	7 3/4 19.7	120 304.8	5,500 2490
RG3-72	72 182.9	8 1/4 22.2	132 335.3	5,800 2630
RG3-84	84 213.4	9 1/4 24.8	144 365.8	6,100 2770
RG3-96	96 243.8	10 1/4 27.3	156 396.2	6,500 2950

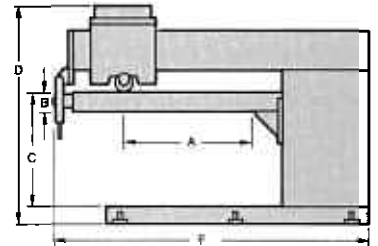
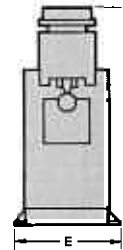

Optional Accessories

VARIABLE SPEED CONTROL

Offers solid state motor drive, giving a variable planishing speed of from 5 to 85 IPM (12.8 cm to 216.8 cm), in place of 85 IPM (216.8 cm/min.).

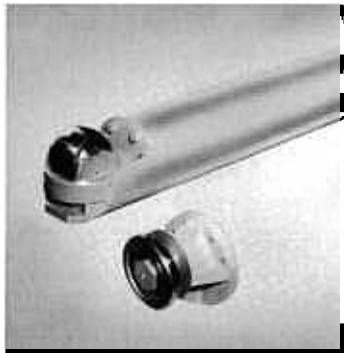

INTERCHANGEABLE ROLLS

Jetline Roll Planishers may be provided with interchangeable rolls for different part configurations. These may be convex up or convex down depending on part configuration. Deep vees and special contours have been made for exotic jet engine parts. Special cantilevered rolls have been made for special access problems using a universal planisher on circumferential joints.

(DPC-1) DUAL PRESSURE CONTROL

Provides for a second low pressure regulator and a manual control that allows the operator to choose a low or high planishing pressure. Low pressure for aligning and roll forming the piecepart; high pressure for planishing.

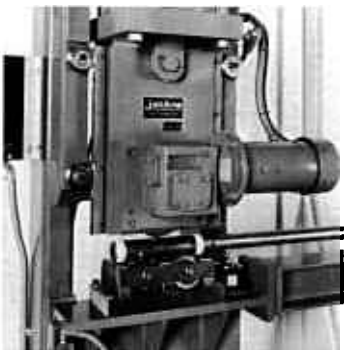

MODEL RS2

The Model RS2 is designed to planish longitudinal welds in small diameters. The machine is capable of accommodating diameter ranges of 1½" - 6" (38 - 152 mm) and lengths of 12' (3.65 m) or more. Material thickness up to .060" (1.5 mm).

The machine uses interchangeable cartridges which match the inside diameter of the part. The cartridge is attached to a mandrel which aligns the cartridge between a set of support rollers and the upper power driven planishing wheel.

The part to be planished is slid over the cartridge and mandrel assembly, then planished between the upper driven wheel and hardened roller contained in the cartridge.

QUICK-CHANGE GEARING

A special design of the upper roll mounting speeds up change-over time when the machine is equipped with a number of interchangeable upper planishing rolls.

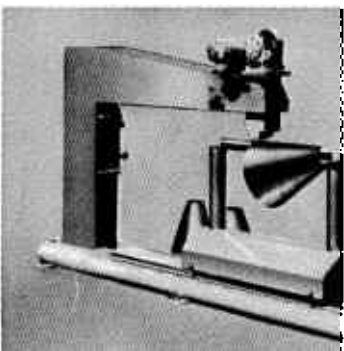

REMOVABLE ARM AND CART

Jetline Roll Planishers are available with a removable lower arm and cart assembly to facilitate the planishing of small diameter or special shape pieceparts. The cart is pulled along the guide track by the action of the powered upper roll. The cart may be removed and the lower arm re-attached for use as a standard planisher.

Distributed By:

jetline[®]
engineering, inc.

15 Goodyear Street, Irvine, CA 92718
(714) 951-1515 Telex 655326
FAX (714) 951-9237